

### Guarantee

All products are manufactured to the highest standards and 5-year guarantee covers any defect in manufacture.

Any part found to be defective during the above guarantee period will be replaced without charge providing that the product has been installed in accordance with our instructions, used as intended and maintained/serviced as recommended.

In the unlikely event that any problems are encountered with this product's performance on installation, you must obtain guidance/authorisation from our Customer Service Department before any remedial action is taken and be able to supply proof and date of purchase.

The guarantee excludes damage caused by accident, misuse or neglect and does not cover the following:

- Those components subject to wear and tear such as 'O' rings and washers etc,
- Damage caused by faulty installation,
- Damage caused by any waterborne debris,
- Damage caused by improper cleaning products,
- Damage caused by the use of non-Bristan parts,
- The product being used for a purpose other than intended.

The company reserves the right, in the event of a claim not covered by the guarantee, to charge the claimant for parts and labour at current rates. This guarantee is given in addition to and does not affect your statutory rights.

*In the interests of continuous product development we reserve the right to alter the specification as necessary.*

### Registration

To register your product with us please complete and return the enclosed registration card.

**PRODUCT CODE: PM THBSM C**

**TELEPHONE HELP LINE! +44 (0) 870 4425553**

Bristan Group Limited  
Birch Coppice Business Park  
Dordon,  
Tamworth  
Staffordshire  
B78 1SG

A Masco company  
Web: [www.bristan.com](http://www.bristan.com)  
Tel: +44 (0) 870 4425553  
Fax: +44 (0) 870 4425554  
Email: [enquire@bristan.com](mailto:enquire@bristan.com)

(FI PM THBSM)

(REV.D1)

(AJ)

# BRISTAN

## Prism Thermostatic Bath Shower Mixer with Dual Thermostatic Control of Bath and Shower

### Fitting Instructions & Contents List



Prior to drilling into walls, check there are no hidden electrical wires, cables or water supply pipes with the aid of an electronic detector. If you use power tools do not forget:

- Wear eye protection
- Unplug equipment after use

Please keep these instructions for future reference and the request of replacement parts

## Contents

Introduction	Page.2
Specification	Page.3
Installation	Page.3
Temperature Setting/Calibration	Page.5
Assembly Drawing	Centre Page
Maintenance	Page.8
Flow Limiters	Page.9
Fault Finder	Page.10
Dimensions	Page.11
Performance	Page.11
Guarantee & Registration	Page.12

## Dimensions

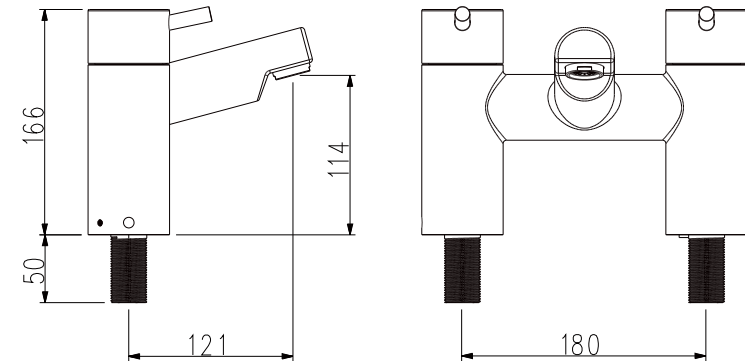
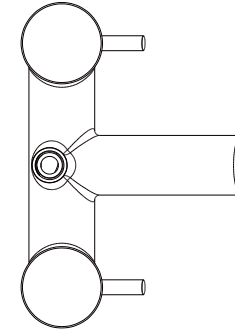

## Introduction

Your Bristan bath shower mixer is a thermostatic mixer incorporating wax capsule thermostats to ensure constant showering temperatures and a safe bath filling temperature.

This valve has been designed to comply with BS EN 1287:1999 & BS EN 1111:1999, manufactured to the highest quality standards and is a 'Water Regulations Advisory Scheme' approved product.

These instructions are for your guidance to a safe and successful installation and should be left with the user.

### Hot Cold Supply Temperatures

Minimum Recommended Hot: 60°C

Maximum Hot Supply: 80°C

Maximum Cold Supply: 20°C

**Please Note: The inlet hot water temperature must be at least 10°C above the required blend temperature to ensure that safety shut off will work.**

## Performance

 Flow limiters not fitted

### BATH FILL :

 Recommend fitting flow limiters

PRESSURE (BAR)	0.2	0.3	0.4	0.6	0.8	1	1	2	3	4	5
FLOWRATE	15.5	20	23.5	29	34	36	16	17	17	17	17

### SHOWER :

(Open Outlet only, does not allow for loss through pipes or fittings)

PRESSURE (BAR)	0.1	0.2	0.3	0.4	0.6	0.8	1	1	2	3	4
FLOWRATE	6	9	11	14	17	20	22	16	19	19	19

**NOTE:** (flow rates in litres/min. On equal pressure drops)

## Fault finder

Fault	Cause	Rectification
No or reduced flow and/or fluctuating temperature	Flow Straightener or Shower Head Blocked.	- Clear debris from Flow Straightner/Showerhead
	- Isolating valve partially closed.	- Open valves.
	- Gravity head of water below minimum requirement.	- Raise tank or fit pump.
	- Blockage in supplies.	- Dismantle and check for debris. Flush supplies before refitting.
	- Other draw offs in use causing pressure or temperature changes.	- Do not use other draw offs whilst in use.
	- Supply pressure unequal.	- See maximum pressure differential in Specifications.
Maximum outlet temperature too hot	- Flow limiters incorrectly fitted.	- Remove and refit to specification.
	- Tap cross circulating.	- Check non return valves and condition of seals.
Maximum outlet temperature too cold	- Maximum temperature incorrectly set.	- Reset maximum temperature [Refer to Temperature section].
Maximum temperature too cold or runs cold after a short time (maximum temperature set or fully adjusted).	- Hot water is less than 10°C above the outlet temperature required.	- Adjust tank temperature to 60-65°C Ensure hot water is up to temperature
		- Check tank or heater capacities.
		- Increase flow through system. Increase pressure in system.
		- Check for blockages. Contact boiler manufacture.
Outlet flow too much.	- Flow limiters incorrectly fitted.	- Remove and refit to specification.
Only hot or cold water at outlet	- Inlet supplies reversed/backwards.	- Ensure supplies are connected correctly to hot or cold inlets.
	- Inlet supplies blocked.	- Clean out debris.
Tap will not shut off or leaking from body.	- Seal damage or wear.	- Renew all seals.
	- Scale build up inside mixer.	- Dismantle and check for debris.
	- Inlet pressure above maximum recommendations.	- Ensure supply pressure are within Specifications. Fit pressure regulating valve if necessary.
No thermostatic fail safe.	- Inlet temperatures not within specifications	- Check inlet temperature, hot supply should be 10°C higher than tap outlet temperature.
	- Piston assembly jammed.	- Dismantle and check for debris.
	- Thermostat failure.	- Replace thermostat.
	- Debris trapped in mechanism.	- Dismantle and check for debris.
	- Inlet supplies reversed.	- Ensure supplies are connected correctly to hot and cold inlets.

## Specification

INLETS:	3/4" BSP INLET TAILS
SHOWER OUTLETS:	1/2" BSP Male iron/15mm compression adapter
WEIGHT:	4.3kg
MINIMUM PRESSURE DROP THROUGH FITTING FOR CORRECT MIXING:	0.2 bar (2 metre head) to bath outlet 0.1 bar (1 metre head) to shower outlet
MAXIMUM PRESSURE DROP THROUGH FITTING FOR CORRECT MIXING:	5.0 bar (50 metre head)
MAXIMUM STATIC PRESSURE TO BE APPLIED TO FITTING:	10.0 bar (100 metre head)
TEMPERATURE STABILITY WITH NOMINAL VARIATION OF SUPPLY TEMPERATURE AND PRESSURES FOR SHOWER:	"+/- 2" Degrees Celcius
TEMPERATURE STABILITY WITH NOMINAL VARIATION OF SUPPLY TEMPERATURE AND PRESSURES FOR BATH:	
FACTORY SET MAXIMUM BLEND TEMPERATURE FOR SHOWER:	43 Degrees Celcius (+0 -2°)
FACTORY SET MAXIMUM BLEND TEMPERATURE FOR BATH:	43 Degrees Celcius (+ 0-2°)
MAXIMUM HOT SUPPLY TEMPERATURE:	80 Degrees Celcius
MAXIMUM PRESSURE LOSS RATIO:	5:1 without flow limiters
	50:1 with flow limiters

## Installation

### General

Installation must be carried out in accordance with the instructions supplied and be installed by a qualified and competent person



Installations must comply with all Local and National Water Authority Regulations, and Building/Plumbing Regulations.

Care must be taken during installation to prevent any risk of injury or damage.

Note! Please refer to the centre page for the part references.

- The bath to which the unit is to be fitted must have 2 holes with a minimum diameter of 26.5mm and a maximum diameter of 38mm set at 180mm centres.
- The mixer needs to be positioned to allow access to the grub screw (40) on the side of the tap.
- To eliminate pipe debris entering the mixer, inline filters (45) have been fitted into the Check Valve Cassettes. **Fitting product without these filters may invalidate any guarantee claim put in against this unit.** It is essential that no debris enters the valve. If installation is on a new build or extensive pipework modification has taken place, it is **essential** to flush the system prior to installing this unit.

### Product Installation

-  For installations on baths with no tap hole decide final position checking the mixer is still fully functional and drill the bath to the sizes on page 3.
- The unit comes with the inlet tails (47) already installed into the main body (35) using the grub screw (40) located under targa button (41). Please note that the inlet tails come with a red 12 Litre flow limiters (44) fitted inside each of the check valve cassettes (43) screwed onto the top of each of the tails (47). Thus, **the unit is Factory set for High Pressure systems**. If it is to be fitted to a low pressure system ie. 1 Bar or below these flow limiters must be removed to ensure satisfactory performance from the unit.
- Remove the back nuts off the inlet tails (47) leaving the white plastic sealing washers in place. Feed the tails through the pre drilled holes in the bath ensuring the white plastic seals are seated into the counterbore in the bottom of inlet tails and secure to bath using the back nuts provided.
- Connect 22mm hot and cold water supplies to mixer using 22mm x 3/4" Tap Connector (**Not supplied**).
- Re-establish water supply.
- Check for leaks.
- Decide the position of the wall bracket, ensuring that the handset and hose can reach the position that has been chosen.
-  Mark out the fixing screw positions and drill wall to suit wall plugs supplied (if required).
- Attach the nut end of the hose to the mixer using one small rubber washer (supplied), and the cone end to the handset with the second washer (supplied).
- Turn on the bath fill and check it functions correctly, open the shower once the bath has been turned off and check the shower side.

Your Bath/Shower mixer comes with 12 litre flow limiters factory fitted into the inlet tails. With these in place the unit can be used on any system that supplies a dynamic pressure of 1 Bar minimum. If the system that the mixer is to be connected to is below this pressure the 2 flow limiters will have to be removed from the inlet tails.(see page 8)

### Flow Limiters At Shower Outlet

The Bath/Shower mixer packing kit has a 10 litre flow limiter included. This has been included with the product so that, in the event that the mixer is delivering too much volume at the shower outlet . It can be limited at this point to allow no more than 10 litres/minute. (See diagram below)

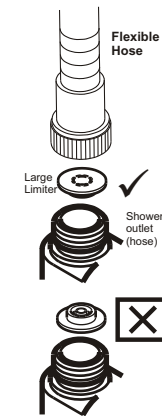

#### **IMPORTANT!** Installations using Combination Gas Boiler systems

When installing this product on above system, fit the 10 litre flow limiter into The Shower outlet . Ensure flow limiter is installed the correct way around. (see above diagram). Failure to fit them on this system will result in unsatisfactory performance from this unit.

**Note!** Boiler must have a minimum temperature rise of 30°C at a flow of 11 litres per minute for satisfactory operation.

## Maintenance

This product has been designed with ease of servicing as its major objective. It is recommended that isolation valves are fitted inline to the mixer for ease of maintenance. With the unit isolated the grub screws (40) can be slackened off using 2.5mm a/flats hexagonal key (supplied). The complete body assembly can now be gently raised off the inlet tail assemblies to reveal the check valve cassette (43) that is screwed into the top of the inlet tail assembly.

### Cleaning of Inline Filters

The unit comes with inline mesh filters (45) fitted to stop debris entering the valve. These must be in place during all operations of the unit. **If the unit is operated without these filters in place it may invalidate your guarantee.** To get access to these filters use a 22mm a/flats open ended spanner to loosen the Check Valve Cassette you will find that the filter (45) is captive between the face of the cassette and the isolating tail body. Wash away any accumulated debris from the filter.

Re-assemble using reverse of instructions above. Care must be taken not to over tighten the Check valve Cassette back into isolating tail as this will cause damage to the black seal that surrounds the filter (45).

### Flow Limiter Removal

The flow limiters (44) are located in a counterbore on the bottom of the Check Valve Cassette they are red in colour to remove them insert a small flat bladed screwdriver into the slots of the limiter and gently prise out. If the white outer casing is left in the counterbore remove this by using the screwdriver to ease this out.

### Check Valves

The unit comes complete with check valves (39) these must also be periodically checked for debris to ensure their correct operation.

### Spares

A full set of spares are available via our service department for this product to order spares please contact our service department on **+44 (0) 870 4425553**

**J THBSM C O-RING SEALS KIT .....SKSOLO3-1**  
**J THBSM C BATH CARTRIDGE.....SKSOLO3-2**  
**J THBSM SHOWER CARTRIDGE.....SKSOLO3-3**

Please refer to centre pages for ordering codes on all other items.

## Temperature Setting/Calibration

### Temperature Setting

For your comfort and safety the unit is factory set for maximum temperature. In the case of the shower side that setting is 41°C +0 -2°C and in the case of the bath the setting is 44°C +0 -2°C.

The unit must be re-calibrated on site to suit supply conditions.

### Calibration Procedure

**Tools Required:-** 2.5mm hexagonal key, thermometer

1. Turn the tap to the fully open position.
2. Unscrew the handle lever (3) at the front of the handle, loosen the grub screw found under the lever (3). (Using the 2.5mm hexagonal key provided).
3. The lever can be pulled off.
4. When looking down onto the top of the cartridge you will be able to see the adjusting screw with a hexagon centre, turning this with the 2.5mm hexagonal key (provided) will increase or decrease the temperature.

**Turn the adjusting screw clockwise for cooler temperature.**

**Turn the adjusting screw anti-clockwise for warmer temperature.**

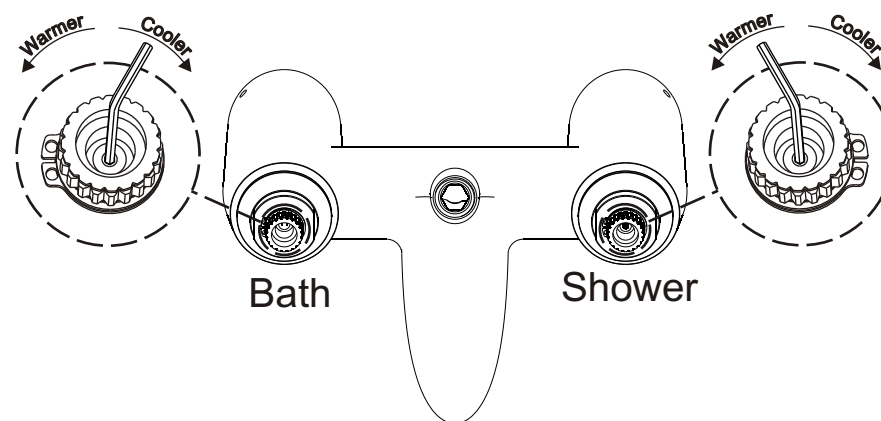

# ASSEMBLY DRAWINGS. & PARTS LIST

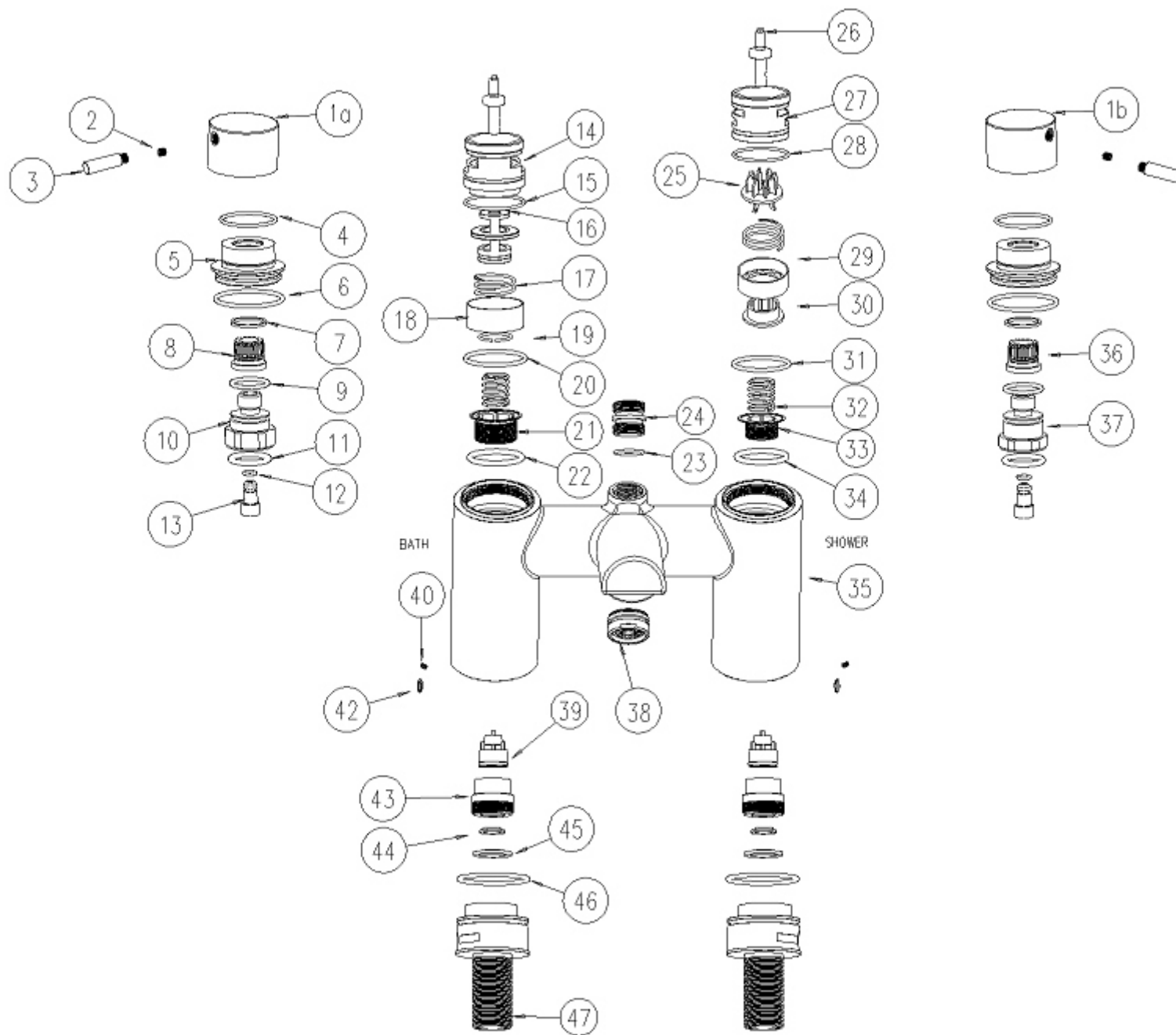

No.	PART NUMBER	DESCRIPTION	QTY	SPARES CODE (SKSOLO3-#)
1a	2400252ECP-B	HANDLE	1	
1b	240252ECP-S	HANDLE	1	
2	540586	M5 GRUB CONE POINT	2	
3	780997	RED AND BLUE INDICE	2	
4	480125	O'RING	2	# = 1/2/3
5	680378	HEAD	2	# = 2/3
6	480131	O'RING	2	# = 1/2/3
7	460181	LARGE PTFE WASHER	2	
8	320084	BATH FLOW NUT	1	# = 2
9	480118	O'RING	2	# = 1/2/3
10	320074	BATH SHUT OFF HEAD	1	# = 2
11	480212	O'RING	2	# = 2
12	480010EP	O'RING	2	# = 1/2/3
13	560552	ADJUSTING SCREW	2	# = 2/3
14	320082	BATH HALF CARTRIDGE	1	# = 2
15	480029	O'RING	1	# = 1/2
16	320073	BATH DISTRIBUTOR	1	
17	360120	SPRING (LARGE)	1	
18	320039	PISTON	1	
19	360068	PLAIN RING	1	
20	480128	O'RING	1	# = 1
21	680314	BATH SEAT RETAINER	1	
22	480218	O'RING	1	# = 1
23	480017	O'RING	1	# = 1
24	780901	OUTLET ADAPTOR	1	
25	320053	PLASTIC DISTRIBUTOR	1	
26	740012	THERMOSTAT	2	
27	320027	SOLO T3 HALF CARTRIDGE	1	
28	480028	O'RING	1	# = 1/3
29	320052	PLASTIC PISTON	1	
30	780856	PLASTIC RETAINING COLLAR	1	
31	480190S	O'RING	1	# = 1
32	360121	RETURN SPRING	2	
33	680313	SHOWER SEAT RETAINER	1	
34	480216	O'RING	1	# = 1
35	150680CP	BODY	1	
36	320024	SHOWER FLOW NUT	1	
37	320079	SHOWER SHUT OFF HEAD	1	
38	600151	M28 FLOW STRAIGHTENER	1	
39	970041	CHECK VALVE	2	
40	540589	M5 GRUB SCREW	2	
41	N/A	N/A		
42	780370CP	CHROME INDICE	2	
43	680308	CHECK VALVE CASSETTE	2	
44	760105	12 L/m FLOW LIMITER	2	
45	780320	M28 FILTER WASHER	2	
46	480132	O'RING	2	# = 1
47	780792	INLET TAIL	2	

