

BRISTAN

Cinnamon Kitchen Sink Tap

Installation Instructions & User Guide



Please keep these instructions for future reference and request of replacement parts

For latest prices and delivery to your door visit MyTub Ltd - www.mytub.co.uk - info@mytub.co.uk

Contents

Thank you for choosing Bristan, the UK's leading taps and showers expert. We have designed this product with your enjoyment in mind. To ensure that it works to its full potential, it needs to be fitted correctly. These fitting instructions have been created to give you all of the information you need and, if you need any further help, please do not hesitate to give us a call on 0844 701 6273.

Important Safety Information	03
General Specifications	03
Dimensions	04
Installation Requirements	05
Installation	06-08
Maintenance	09
Troubleshooting	10
Guarantee	11

Important Safety Information

- Please read these instructions thoroughly and retain for future use.
- All products manufactured and supplied by Bristan are safe provided they are installed correctly, used correctly and receive regular maintenance in accordance with these instructions.
- If you are in any doubt about your ability to install this product safely you must employ the services of an experienced qualified plumber.
- Remove all packaging and check the components for damage before starting installation.
-  Before starting any installation please consider the following: Prior to drilling into walls, check that there are no hidden electrical wires, cables or water supply pipes. This can be checked with the aid of an electronic detector.
- If power tools are used do not forget to:
 - Wear eye protection
 - Unplug equipment after use
- This product **must** not be modified in any way as this will invalidate the guarantee.
- These fittings need to be installed in accordance with and meet the requirements of the Water Supply (Water Fittings) Regulations 1999 and Scottish Byelaws 2004.

General Specifications

Operating pressure range (bar)	Min	Max
	0.3	7.0

Maximum static pressure – 10.0 bar

NOTE:- Nominally equal (balanced) inlet supply pressures are recommended for optimum Performance of mixer taps.

Designed to comply with BS EN 200 for single taps / combination taps for water systems of type 1 and 2 general technical specifications; and to be used within systems designed to BS 6700.

BS 6700 recommends the temperature of stored water should never exceed 65°C. A stored water temperature of 60°C is considered sufficient to meet all nominal requirements and will minimise the build up of lime scale in hard water areas.

Dimensions

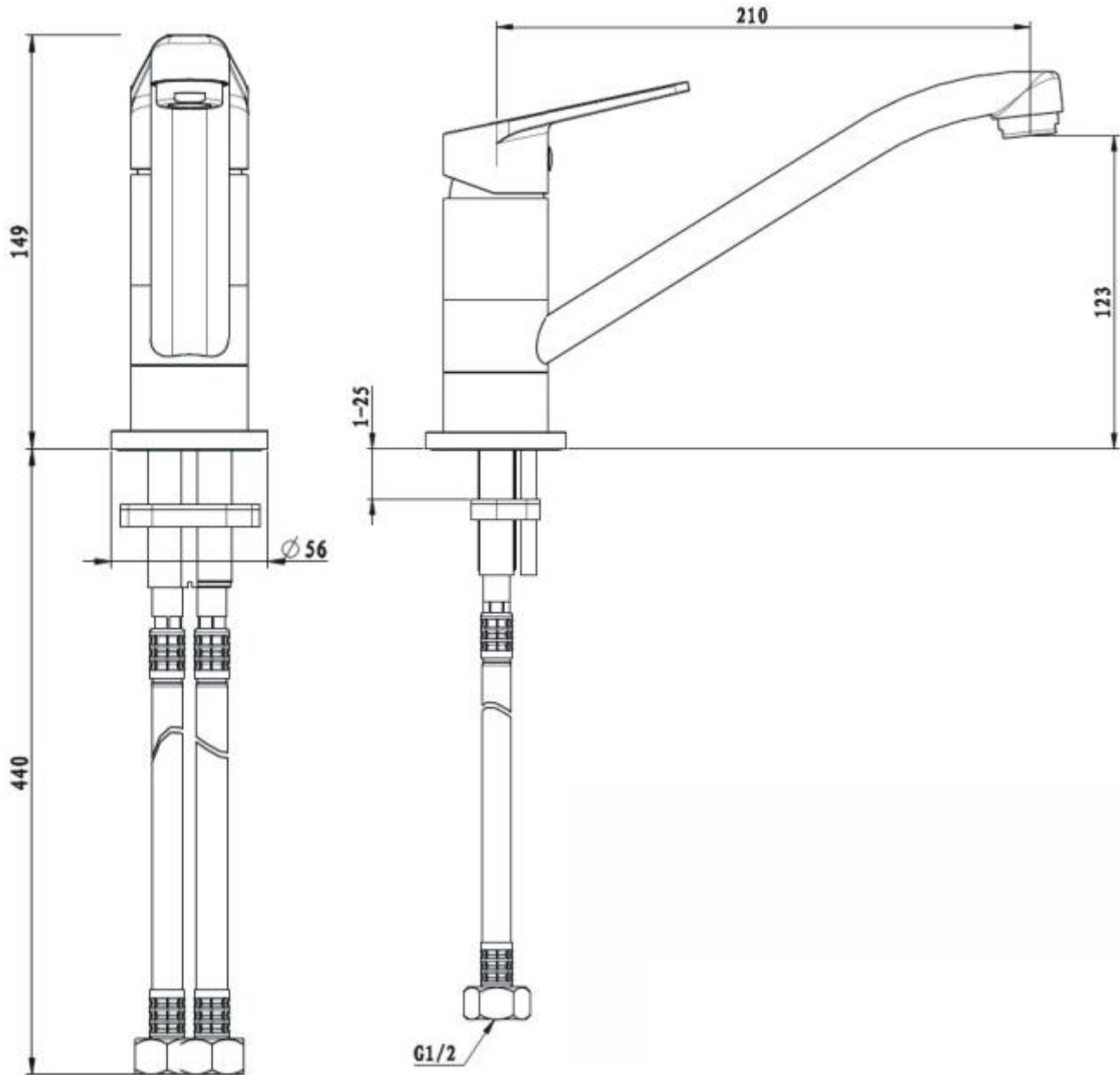

All measurements are in mm and are approximate

Installation Requirements.

Flexible Connecting Pipes

Care must be taken when connecting the flexible connection pipes to the household pipework to ensure they do not bend sharply and kink or twist.

See below for recommended ways to fit the flexible connecting pipes

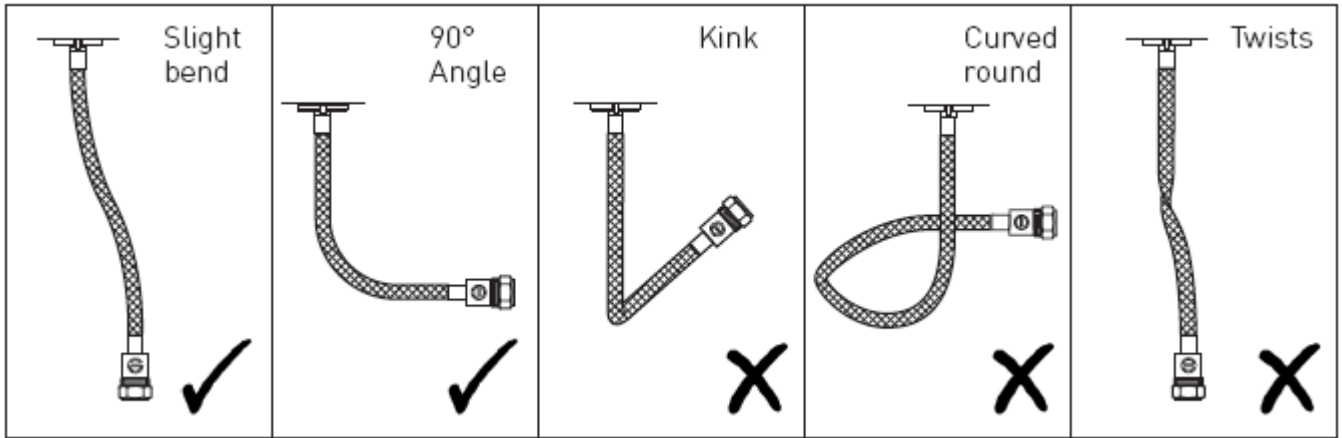

! **Important:** Failure to follow these guidelines may result in poor performance and damage to the flexible connecting pipes

Isolation Valves

The isolation valves must be accessible with a suitable flatblade screwdriver for turning on and for future servicing purposes

See below for the off and on positions of the isolation valves.

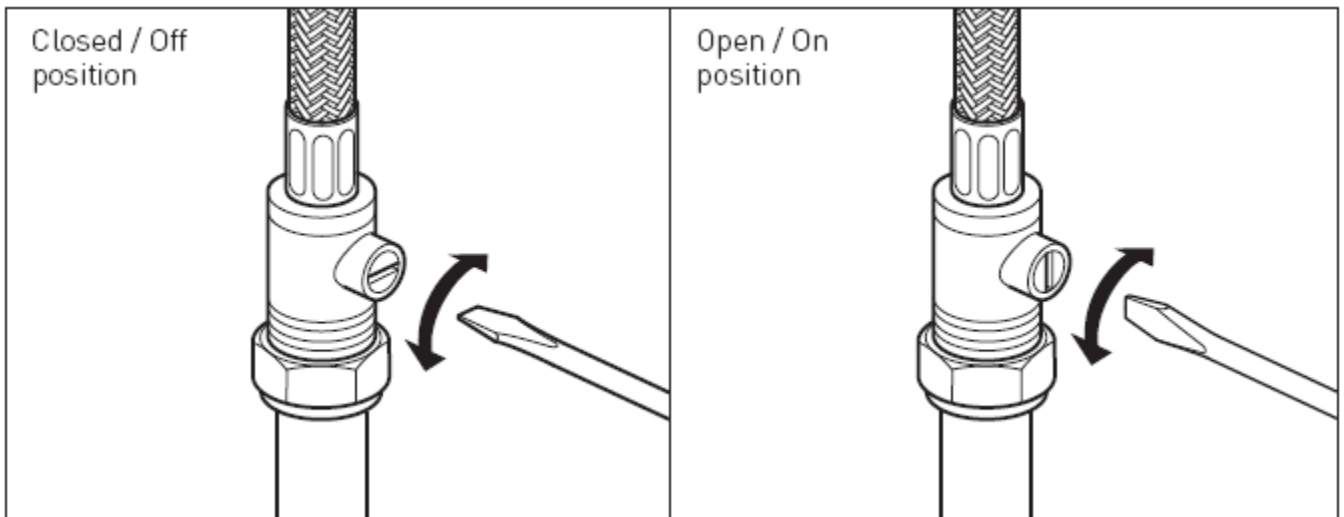

Installation.

Identify all components are present prior to starting installation using the diagram on page 08.

1.	Handle	x1	10.	Hot & Cold Connectors	x1
2.	Grub Screw Cap	x1	11.	Push Fit Connector	x1
3.	Grub Screw	x1	12.	Stepped Rubber Washer	x1
4.	Shroud	x1	13.	Rubber Seal	x1
5.	Cartridge Retaining Nut	x1	14.	Re-Enforcing Plate	x1
6.	Cartridge	x1	15.	Back Nut	x1
7.	Mixer Body (pre-assembled)	x1	16.	Grub Screw	x1
8.	Plinth	x1	17.	Anti-Splash Assembly	x1
9.	O-Ring	x1	18.	Flexible Connecting Pipes	x2
			19.	Isolation Valves	x2

Flush through the pipework to ensure removal of debris. Turn off the mains water supply and close any isolating valves.

1. Fit push-fit connector

Place the 'push-fit connector' into the hole in the basin top. Ensure the rubber washer is fitted to the underside and the side with 'FRONT' on is at the front.

2. Attach hot and cold connectors

The re-enforcing plate provided (not shown in diagram) is to distribute the weight of the tap if fitted to thin worktops/stainless steel sinks. If required, this should be fitted underneath work surface above the back nut. Position the back nut under the basin (with the rubber seal on top), ensuring the locating pin fits into the hole in the back nut. Insert and loosely tighten the threaded cold connector by turning the 6mm hexagonal key clockwise. Once threading has started you can let go of the back nut. Before fully tightening the cold connector, place the 'hot connector' into the push-fit connector - ensure it fits fully through the basin hole.

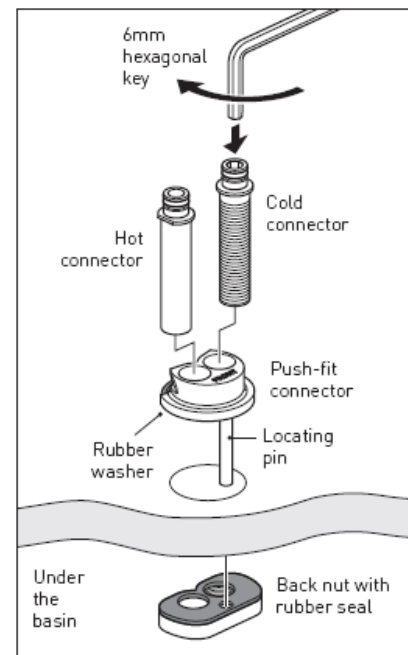

Note: The hot connector has 2 flat edges at the top to allow it to fit fully down and close to the top of the cold connector. Failure to do this may prevent the tap fitting onto the connector.

! **Important:** The push-fit connector must be fully tightened to the back nut before attaching the flexible connecting pipes.

Installation Cont.

3. Attach flexible connecting pipes.

⚠ Important: Before connecting the flexible connecting pipes, please refer to the specific installation requirements on page 6. Carefully screw the 'flexible connecting pipes' into the 'push-fit connectors'. Fit the isolation valves (supplied) to the flexible connection pipes and turn to the 'closed' position as shown on page 6.

Note: A flexible connecting pipe can be fed up through the hot connector hole and then screwed on if required.

⚠ Important: Only tighten the flexible connecting pipe by hand. Do not overtighten. Connect the isolation valves/flexible connecting pipes to the household water supply pipes.

4. Cover cap

If required place the cover cap over the push-fit connector until the tap body is ready to be fitted.

5. Fit the tap body

Remove the cover cap and place the plinth over the push-fit connector. Grease the push-fit connector using the sachet of grease provided. Push-fit the tap body onto the connector. Align the body and tighten the grub screw at the rear of the body, using the long end of the 2.5mm hexagonal key as shown below until finger tight. Remove the hexagonal key and insert the short end into the grub screw and tighten an extra $\frac{3}{4}$ to 1 complete turn more to ensure the tap body is securely tightened to the push-fit connector.

⚠ Important: The fitting must be securely attached to the base.

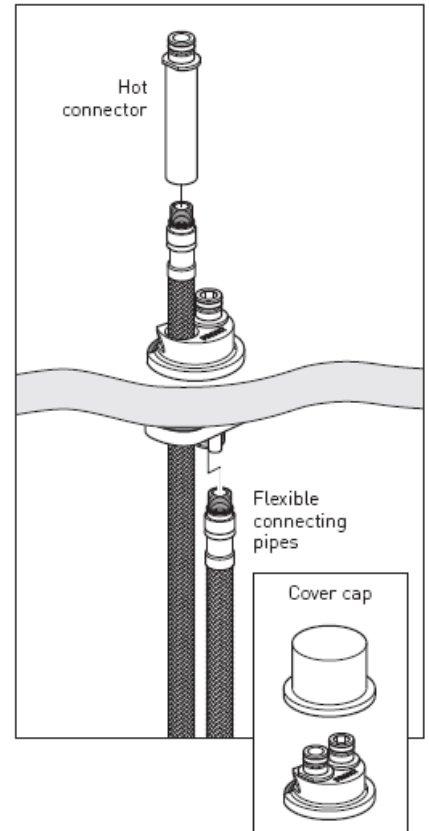
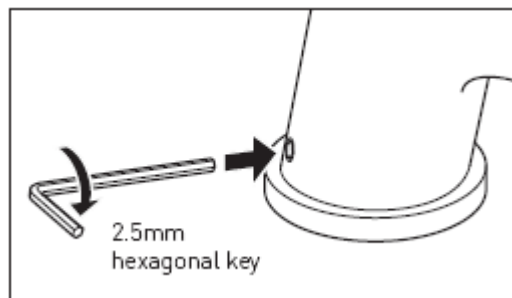

* Tap body may vary to the one shown here

Turn on the mains water supply and open the isolating valves using a suitable flat blade screwdriver. (See page 05)

Operation

Lifting the lever up from the body will turn on/off and increase/decrease the flow of water. Moving the lever towards either the left or right will increase or decrease the water temperature.

Installation cont.

Basin Mixer

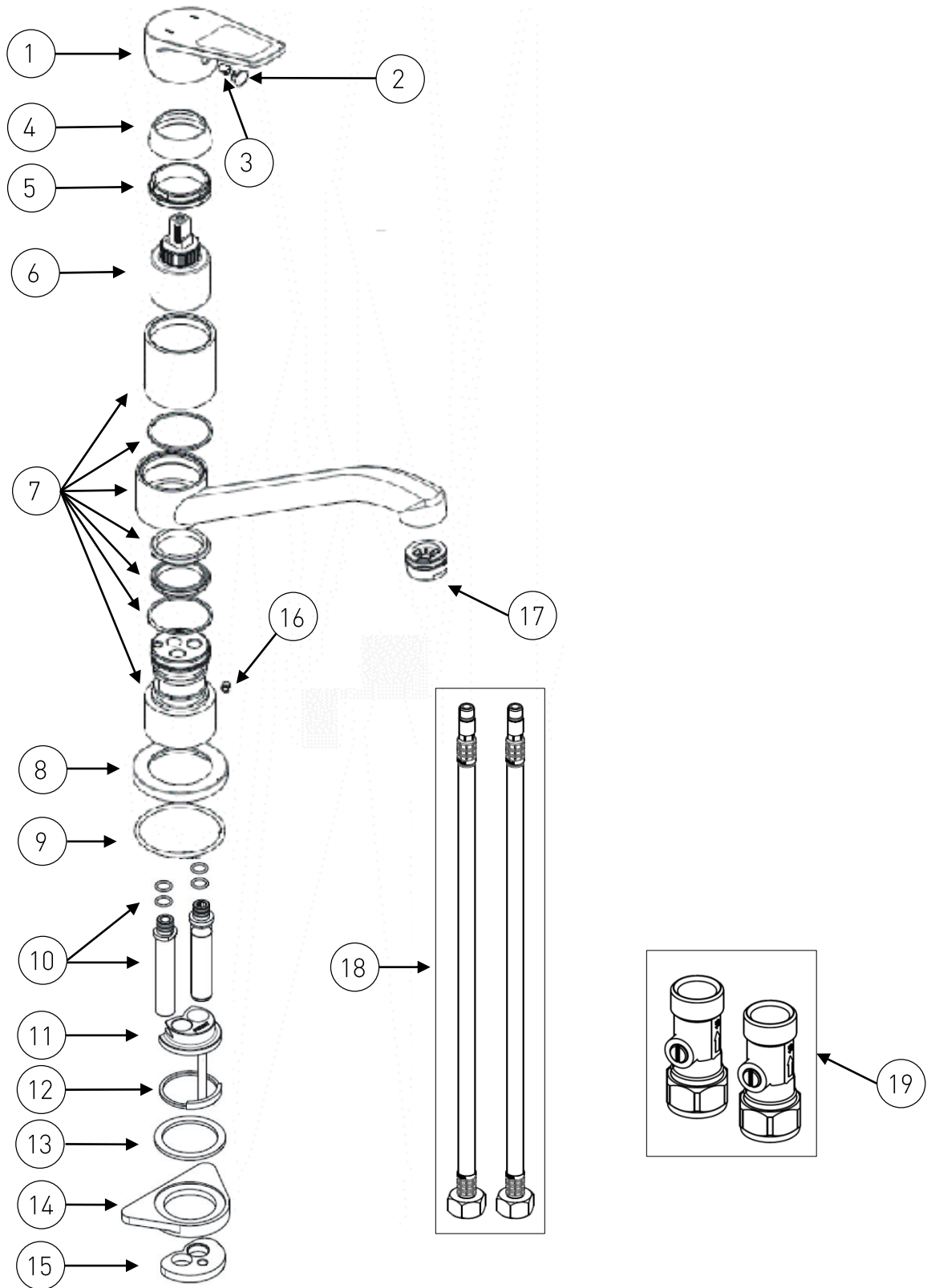

Maintenance

General Cleaning

Your fitting has a high quality finish and should be treated with care to preserve the visible surfaces. All finishes will wear if not cleaned correctly. The only safe way to clean your product is to wipe with a soft damp cloth. Stains can be removed using washing up liquid. All bathroom cleaning products (powders and liquids) will damage the surface of your fitting, even the non-scratch cleaners.

Note: Never use abrasive detergents or disinfectants or those containing alcohol, hydrochloric acid or phosphoric acid.



Bristan recommend E-cloth for cleaning all of our bathroom & kitchen products. Using just water, E-cloth gives a smear free, deep clean by breaking up and holding dirt, which normal cloths leave behind. Order through your Bristan stockist. (order code: ECLOTH).

If your fitting begins to leak the following should be carried out;

Isolate both hot and cold water supplies to the tap by either:

- Turning the water supply off at the mains stopcock or
 - Turning off the isolation valves to the tap.
1. Remove the cap (2) at the front of the handle (1) to reveal the concealed grub screw (3).
 2. Unscrew the grub screw (3) and remove the handle (1) by pulling away from the shroud (4).
 3. Unscrew the shroud (4) and remove the cartridge retaining nut (5). Pull out the cartridge (6).
 4. Carefully clean the cartridge seals and seating on the base of the cartridge (6).
 5. If necessary replace the cartridge.

Please visit www.bristan.com/sparesfinder in order to find spare parts for this product.

6. Replace the cartridge into the tap body (7) and tighten retaining nut (5) fully.
7. Replace all remaining components and turn on water supply.
8. Check for leaks and contact our helpline if problem persists.

Troubleshooting

Symptom	Cause	Remedy
No flow or poor flow rate.	Partially closed stop or service valve in water supply pipework to the tap.	Open stop or service valve.
	Head of water is below the minimum distance required.	Refer to the Specification section for minimum pressures required.
	Possible airlock / blockage in supply pipework	Remove water supplies from the fitting and flush the system to remove any airlocks / debris.
	Cartridge / Valve not opening fully.	Service fitting. Refer to maintenance section on page 09.
Water dripping for a few seconds after the tap has been turned off.	This is caused by 'capillary action' and residual water in the spout being siphoned out. This should only last for a couple of seconds.	
Constant dripping / leaking when the tap is not in use.	Cartridge / Valve not fully shutting off.	Service fitting and replace cartridge / valve. Refer to maintenance section on page 09.
Fitting does not turn on.	Water supplies not turned on.	Check that the water supplies to the fitting are turned on.
	Closed stop or service valve.	Open stop or service valve.

Bristan Guarantee

Bristan offers solid guarantees to provide you with complete peace of mind.

Taps and Mixers

5 year parts and 1 year labour*. Gold, painted and special finishes 3 years parts only.

All subject to proof of purchase.

Mixer Shower Valves

5 year parts. 5 year labour* (subject to registration), or 1 year with proof of purchase.

Gold, painted and special finishes 3 years parts only.

Pumps and Power Showers

2 year parts. 1 year labour* (subject to registration).

Electric Showers/Instantaneous Water Heaters

2 year parts. 1 year labour* (subject to registration).

Accessories

5 year parts only. Includes bathrooms accessories, shower accessories (e.g. hoses, handsets and poles), wastes, WC levers and light pulls. Gold, painted and special finishes 3 years parts only.

Sanitaryware

5 year parts only. Subject to proof of purchase.

*Labour provided by an approved Bristan engineer. Guarantee only applies to products with a manufacturing fault. A deferred payment will be necessary in order to secure any visits by our engineers which will be charged if the problem is found **not** to be a manufacturing fault. If the fault is found to be down to a manufacturing error, the payment will be released and not charged.

This guarantee applies to products purchased within the United Kingdom or Republic of Ireland, but does not apply to products used commercially.

The guarantee is only available to original purchasers who have proof of purchase.

The installation must allow ready access to all products for the purpose of inspection, maintenance or replacement.

Any part found to be defective during the above guarantee period will be replaced without charge, providing that the product has been installed in accordance with the instructions, used as intended, and regularly serviced.

Servicing should be carried out at regular intervals of no more than 12 months and more frequently in hard water areas (heavy lime scale) areas.

In the unlikely event that any problems are encountered with the product's performance on installation, you must obtain guidance/authorisation from our Customer Service Department, and be able to supply proof and date of purchase, before any remedial action is taken.

The guarantee excludes general wear and tear and damage caused by accident, misuse or neglect, and does not cover the following:

- Components that are subject to general wear and tear such as filters, seals, 'O' rings and washers etc.
- Damage caused by faulty installation
- Damage caused by lime scale or any waterborne debris
- Damage caused by inappropriate cleaning products (see user instructions)
- Damage caused by the use of non-Bristan parts
- The product being used for a purpose other than intended by the manufacturer.

In the interests of continuous product improvement Bristan reserves the right to alter specification as necessary.



Guarantee

BRISTAN

This booklet covers product code:

CNN EFSNK C

Helpline

0844 701 6273

Bristan Group Limited

Birch Coppice Business Park, Dordon, Tamworth, Staffordshire B78 1SG

A Masco Company

Website: www.bristan.com

Telephone: 0844 7016 274 Facsimile: 0844 701 6275

Email: enquire@bristan.com