

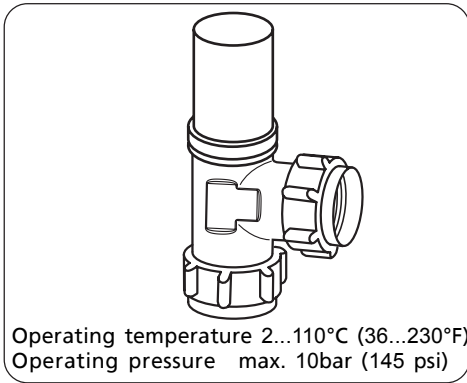

Installation Guide

for EHE0200281 Automatic Bypass Valve

Application



A bypass circuit must be installed if the boiler manufacturer requires it, or specifies that a minimum flow rate has to be maintained when the boiler is in operation. An automatic bypass valve (ABV) is designed to control the water flow in the heating circuit and is used to maintain a minimum flow rate through the boiler and limit circulation pressure when other water channels are closed or closing down. Using an ABV becomes particularly important when thermostatic radiator valves (TRV's) are used on a heating system. Whilst TRV's are open, the ABV remains closed, but as the TRV's start to close, the ABV starts to open maintaining the required flow rate through the boiler. The use of an ABV can also reduce noise in systems caused by high water velocities. The building regulations require the use of an ABV.

Location in System

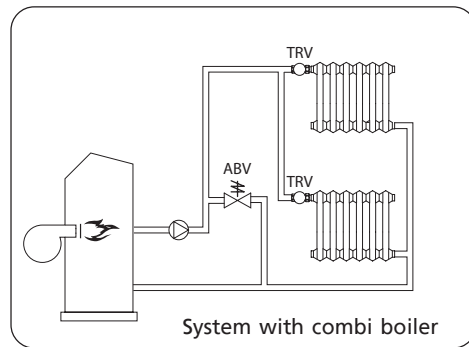
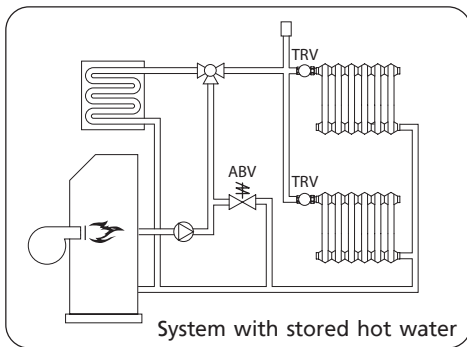

Installation

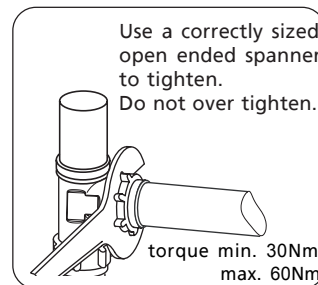
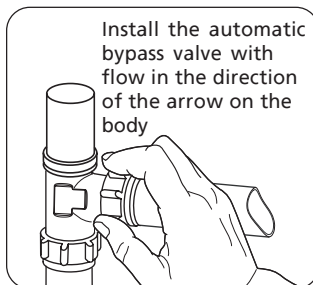
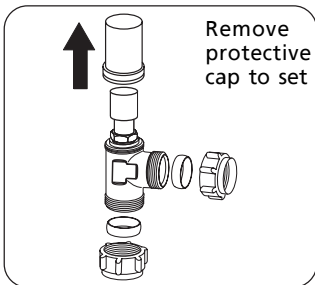

50031583-001

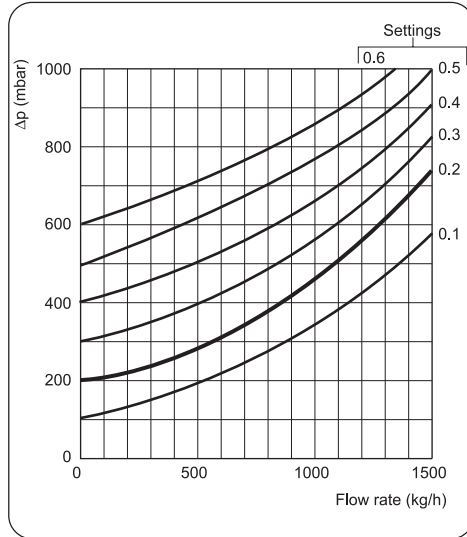

Setting Procedure

1. Balance the heating system and make a note of the pump speed.
2. Determine the minimum flow rate for the boiler by referring to the boiler manufactures instructions.
3. Use the pump manufactures instructions to determine the pump head when operating at the minimum flow rate.
4. Using the determined minimum flow rate and pump head, use the chart opposite to calculate the setting for the ABV.
5. To set the ABV, remove the cap and turn the setting handle until the bottom of the handle crosses the corresponding line on the valve stem.

Notes:

1. **The cap is internally fixed with sealing wax during assembly. Turn the handle firmly to break this seal.**
2. **If water velocities occur in the heating system, gradually turn the ABV to a lower setting until the noise is eliminated.**
3. **Replace protective cap after setting the ABV to make it tamperproof.**

For further information telephone 0870 8506538

Whilst every care has been taken to ensure that the information included in this document was accurate at the time of printing, we reserve the right to change specifications at any time. The photographs reproduced in this publication are within the constraints of the printing process and are NOT to be used for matching purposes. E&OE.

a **WOLSELEY** company
Ref: 4277

