

C1/SFB

(52.5)

IH4

2nd June 2008
1st Revision



Trade Price List



Five Good Reasons To Trust

Member of



Alutec Rainwater Colours

Polyester powder coated range of RAL colours with 30% low gloss finish that are available as standard (unless otherwise stated):-
Please quote the RAL number and colour reference with your order.



Additional colours, finishes and gloss levels are available, price on application.

*Aligator® Classic basic colours

This chart is a representation of the actual colours, for exact match please ask for sample plates.

Sealant usage table

100mm half round	18
113mm half round	16
125mm half round	14
100mm Victorian Ogee	14
113mm Victorian Ogee	12
125mm Victorian Ogee	11
100mm Moulded.....	11
125mm Moulded	9
150mm Moulded	7

Approximate number of joints per tube of Alutec sealant

Aligator® Deepflow.....	6
Aligator® No 46 Ogee.....	4
120 x 80mm Aligator® Boxe.....	5
135 x 100mm Aligator® Boxer	4
160 x 100mm Aligator® Boxer	4
Aligator® Viscount	4
Aligator® Box Eaves	3
Aligator® Giant	3
Aligator® Classic.....	5

63mm dia. pipe socket	25
76mm dia. pipe socket	20
102mm dia. pipe socket	15
72 x 72mm pipe socket.....	17
102 x 76mm pipe socket.....	13
102 x 102mm pipe socket.....	12
62 x 62mm pipe socket.....	20
310ml Tube of sealant = approximately 6 linear metres of 8mm diameter bead.	

Please note that sealant shelf life is 12 months









ALIGATOR®
 'SNAP FIT'
 Joint Method
 patent No. GB2327955

Rainwater harvesting systems available from Marley Plumbing & Drainage.



For further information on this or any other product from the Marley Plumbing & Drainage range, please call customer services on 01622 852585

RAINWATER

Aligator® Classic Gutter & Downpipes	2	
Aligator® Deepflow	3	
Aligator® No 46 Ogee	3	
Aligator® Viscount	3	
Aligator® Boxer	4	
Aligator® Giant	4	
Aligator® Box Eaves	5	
Half Round	5	
Victorian Ogee Cast	6	
Moulded Ogee Cast Gutter	6	
Rafter Arms and Rise & Fall Brackets	7	
Hoppers	7	
Leafguards	7	
Circular Downpipe	8	
Vortex Downpipe	9	
Square, Rectangular Downpipe	10	
Vandal Resistant Downpipe	11	
Accessories	12	

ROOF OUTLETS 12/13/14

FLOOR OUTLETS 15

Nickel Bronze Grate Accessories 15





Shower Outlets & Spares 16

Prices are quoted as 'PPC' - Polyester powder coated aluminium or 'Plain' - unpainted aluminium



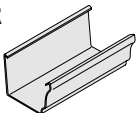

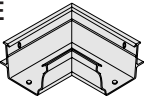
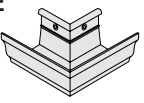
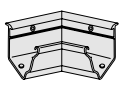
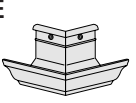
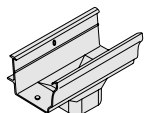
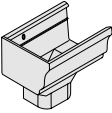
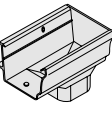
Aluminium Rainwater

Aligator® snap fit Classic

120 X 75MM OGEE STYLE GUTTER

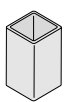

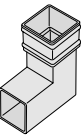
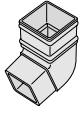
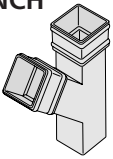
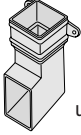
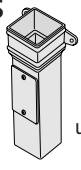

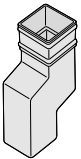
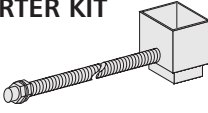
Description	Code	Black, White or Heritage Black*	Other standard PPC colours
GUTTER  3m	GK413	33.57	53.67
UNION 	GK420	4.89	6.37
FASCIA BRACKET  (external)	GK480	3.09	3.96
ANGLE  90° int ①	GK430	22.50	27.54
ANGLE  90° ext ①	GK431	22.50	27.54
ANGLE  135° int ①	GK435	22.50	27.54
ANGLE  135° ext ①	GK436	22.50	27.54
RUNNING OUTLET  63mm Ø 62 x 62mm	GK421	26.86	37.61
STOP END OUTLET  LH	GK428	37.53	51.03
STOP END OUTLET  RH	GK429	37.53	51.03
STOP END  LH	GK450	5.24	6.65
STOP END  RH	GK455	5.24	6.65

62MM SQUARE DOWNPIPE SYSTEM

Description	Code	Black, White or Heritage Black*	Other standard PPC colours
PIPE  3m	RK313	37.27	46.33
SOCKET  use SC605 screw	RK320	6.65	7.40
PLAIN SOCKET 	RK320NE	6.65	7.40
BEND  92.5°	RK330	20.08	21.85
BEND  112.5°	RK332	9.20	10.21
BRANCH  112.5°	RK342	37.53	40.29
SHOE  use SC605 screw	RK350	20.48	22.17
ACCESS PIPE  use SC605 screw	RK360	25.44	28.88
PIPE CLIP  one pce use SC605 screw	RK380	2.76	3.09
WALL OFFSET  50mm offset	RK3902	27.87	30.22
RAINWATER DIVERTER KIT  only available in PVCu	RK25B (BLACK) RK25W (WHITE)	31.58 31.58	

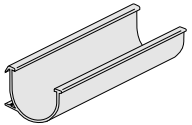

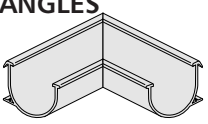
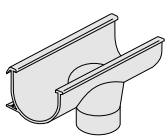

Aligator® snap fit Deepflow

130 X 80MM DEEP HALF ROUND SYSTEM

Description		Code	PPC	Plain
GUTTER				
	1m 2m 3m	GD511 GD512 GD513	34.75 67.69 98.69	32.62 63.01 91.13
UNION CLIP	(internal)	GD520	4.73	3.38
				
FASCIA BRACKET	②	GD580	2.13	1.24
				
ANGLES				
	90° int 90° ext 135° int 135° ext non std angle ①	GD530 GD531 GD535 GD536 GD539	36.96 36.96 36.96 36.96 POA	32.19 32.19 32.19 32.19 POA
OUTLET				
	63mm Ø 76mm Ø 102mm Ø 72x72mm 102x76mm 102x102mm	GD522 GD523 GD524 GD525 GD526 GD527	28.28 30.71 48.00 36.69 44.22 50.79	24.48 26.91 44.22 32.88 40.42 47.03
STOP END	(internal)	GD550	19.40	17.88
				

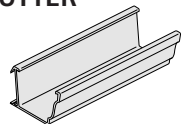

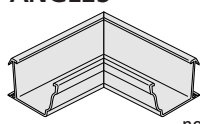
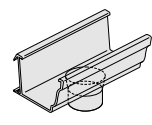
Aligator® snap fit Ogee No 46



155 X 100MM NO 46 OGEE SYSTEM

Description		Code	PPC	Plain
GUTTER				
	1m 2m 3m	GG511 GG512 GG513	43.73 85.64 125.55	40.67 79.14 115.38
UNION CLIP	(internal)	GG520	5.86	3.94
				
FASCIA BRACKET	②	GG580	2.35	1.37
				
ANGLES				
	90° int 90° ext 135° int 135° ext non std angle ①	GG530 GG531 GG535 GG536 GG539	39.95 39.95 39.95 39.95 POA	34.72 34.72 34.72 34.72 POA
OUTLET				
	63mm Ø 76mm Ø 102mm Ø 72x72mm 102x76mm 102x102mm	GG522 GG523 GG524 GG525 GG526 GG527	30.33 32.71 40.26 41.99 45.72 48.79	25.61 27.96 35.52 37.28 41.01 44.06
STOP END	Left Hand (int) Right Hand (int)	GG550 GG555	23.01 23.01	21.13 21.13
				

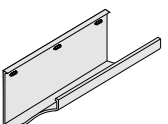
Aligator® Viscount

150 X 121MM GUTTER SYSTEM

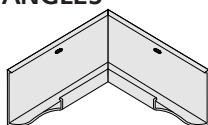
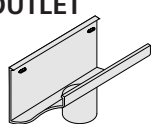
Description		Code	PPC	Plain
GUTTER				
	1m 2m 3m	GA611 GA612 GA613	46.27 90.59 132.96	41.09 80.37 117.88
UNION CLIP	(internal)	GA620	7.38	5.53
				

Description		Code	PPC	Plain
ANGLES				
	90° int 90° ext 135° int 135° ext non std angle ①	GA630 GA631 GA635 GA636 GA639	51.21 51.21 51.21 51.21 POA	45.59 45.59 45.59 45.59 POA
OUTLET				
	63mm Ø 76mm Ø 102mm Ø 72x72mm 102x76mm 102x102mm	GA622 GA623 GA624 GA625 GA626 GA627	34.61 42.75 45.31 47.14 51.09 54.37	29.49 37.64 40.18 42.04 45.97 49.25
STOP END	Left Hand (int) Right Hand (int)	GA650 GA655	25.60 25.60	23.57 23.57
				





PPC = Polyester Powder Coated supplied to our standard range of colours. When ordering PPC prefix code by 'X' and state colour and RAL number - see inside front cover.

① = Please phone for quote stating angle and if internal or external.

② = Brackets are concealed when fixed to typical fascia and therefore will be supplied plain unless otherwise stated.

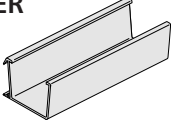

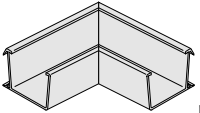
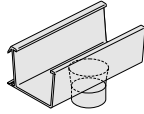

Aluminium Rainwater

Aligator® snap fit Boxer Gutter

Description	120 x 80mm			135 x 100mm			160 x 100mm			
	Code	PPC	Plain	Code	PPC	Plain	Code	PPC	Plain	
GUTTER 	1m	GF411	27.47	19.50	GF511	39.01	29.04	GF611	41.65	30.83
	2m	GF412	53.71	37.78	GF512	77.53	56.90	GF612	82.14	60.46
	3m	GF413	78.79	54.90	GF513	113.38	83.57	GF613	121.53	88.99
UNION CLIP  (internal)	GF420	5.52	3.04	GF520	6.39	3.80	GF620	6.82	4.00	
FASCIA BRACKET  ②	GF480	2.32	1.31	GF080	2.35	1.37	GF080	2.35	1.37	
ANGLES  90° int 90° ext 135° int 135° ext non std angle ①	GF430	30.69	25.60	GF530	39.10	33.83	GF630	41.14	35.92	
	GF431	30.69	25.60	GF531	39.10	33.83	GF631	41.14	35.92	
	GF435	30.69	25.60	GF535	39.10	33.83	GF635	41.14	35.92	
	GF436	30.69	25.60	GF536	39.10	33.83	GF636	41.14	35.92	
	GF439	POA	POA	GF539	POA	POA	GF639	POA	POA	
OUTLET  63mm Ø 76mm Ø 102mm Ø 72x72mm 102x76mm 102x102mm	GF422	26.26	22.50	GF522	29.24	24.45	GF622	30.42	24.66	
	GF423	26.26	22.50	GF523	29.24	24.45	GF623	30.42	24.66	
	GF425	35.70	31.69	GF525	41.39	36.62	GF625	42.48	36.72	
	GF426	42.29	37.94	GF526	48.84	40.06	GF626	45.89	40.13	
				GF527	49.23	44.43	GF627	50.20	44.48	
STOP END  Left hand (int) Right hand (int)	GF450	16.33	14.52	GF550	20.41	18.53	GF650	22.36	20.28	
	GF455	16.33	14.52	GF555	20.41	18.53	GF655	22.36	20.28	

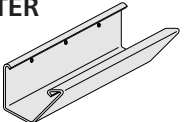
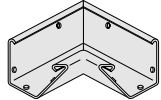

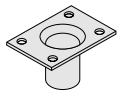

Aligator® snap fit Giant

200 X 150MM GUTTER SYSTEM

Description	Code	PPC	Plain	Description	Code	PPC	Plain
GUTTER  3m	GH813	142.00	110.10	ANGLES  90° int 90° ext 135° int 135° ext non std angle	GH830	73.05	61.69
UNION CLIP  (external)	GH820	13.20	12.61		GH831	73.05	61.69
					GH835	73.05	61.69
					GH836	73.05	61.69
					GH839	POA	POA
STIFFENER BRACKET & SPACER ASSEMBLY  4 stiffener brackets required to each 3m gutter length	GH885		5.46	PATCH OUTLET  76mm Ø 102mm Ø 72x72mm 102x76mm 102x102mm	GH823	33.24	30.43
					GH824	33.24	30.43
					GH825	33.24	30.43
					GH826	33.24	30.43
					GH827	33.24	30.43
STOP END  (external) LH (external) RH	GH855		5.46	STOP END  (external) LH (external) RH	GH850	40.39	36.04
					GH855	40.39	36.04

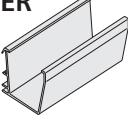
Aligator® Box Eaves Gutter



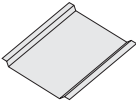
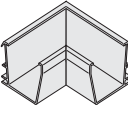
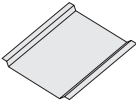
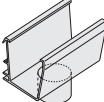
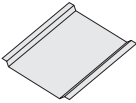
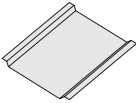
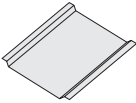
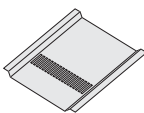
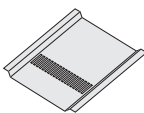
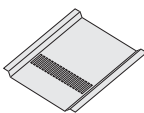
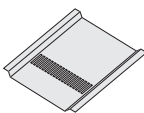
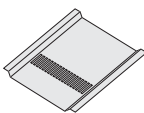
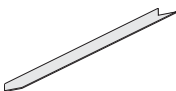
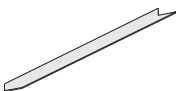
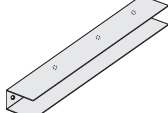

175 X 150MM GUTTER SYSTEM

Description		Code	PPC	Plain	Description		Code	PPC	Plain
GUTTER	 3m	GL713	192.83	163.22	INTERNAL STOPEND				
					 LH	GL750	34.00	31.91	
						RH	GL755	34.00	31.91
UNION		GL720	9.21	8.48	SOFFIT PANEL*				
FASCIA BRACKET	 ②	GL780	2.25	1.38	 300mm	GL791	19.38		
ANGLES	 90° int 90° ext 135° int 135° ext	GL730 GL731 GL735 GL736	72.83 72.83 72.83 72.83	70.25 70.25 70.25 70.25	 500mm	GL792	26.44		
RUNNING OUTLET	 76mm 102mm 72x72mm 102x76mm 102x102mm	GL723 GL724 GL725 GL726 GL727	49.01 49.01 49.01 49.01 49.01	45.75 45.75 45.75 45.75 45.75	 750mm	GL793	35.33		
					 1000mm	GL794	45.97		
					 1500mm	GL795	63.75		
					VENTILATED SOFFIT PANEL*				
					 300mm	GL791V	22.26		
					 500mm	GL792V	29.35		
					 750mm	GL793V	37.66		
					 1000mm	GL794V	48.87		
					 1500mm	GL795V	66.67		
					MITRE COVER STRIP				
					 1100mm	GL796	12.79		
					 2100mm	GL797	22.97		
					WALL CHANNEL				
					 3m	GL798	32.61		

*Please refer to technical literature for assembly details. Soffit panels will be manufactured to the required projection (maximum 1500mm).

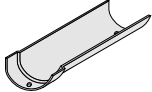
When ordering soffit panels, use the product code nearest to the size required, e.g. a 285mm soffit panel will be referred to as GL791 (300mm). Clearly state the exact dimension required when requesting a quote.

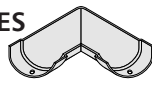
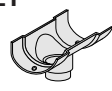
Half Round Gutter System

Description	100mm (4")			113mm (4½")			125mm (5")			
	Code	PPC	Plain	Code	PPC	Plain	Code	PPC	Plain	
GUTTER	 1.83m	GC406	35.54	23.04	GC106	37.01	25.48	GC506	41.45	27.85
UNION CLIP	 (external)	GC420	6.59	5.33	GC120	7.10	5.65	GC520	7.85	6.58
FASCIA BRACKET		GC480	2.82	1.93	GC180	2.95	2.00	GC580	4.66	3.67
ANGLES	 90° 135° non std angle ①	GC432 GC437 GC439	11.26 26.74 POA	8.65 23.22 POA	GC132 GC137 GC139	12.88 28.39 POA	9.94 24.50 POA	GC532 GC537 GC539	14.39 29.84 POA	11.80 27.29 POA
OUTLET	 63mm Ø 76mm Ø 102mm Ø 72x72mm 102x76mm	GC422 GC423 GC425	17.70 17.70 36.96	14.72 14.72 32.83	GC122 GC123 GC125	16.41 16.41 35.65	13.24 13.24 31.38	GC522 GC523 GC524 GC525 GC526	16.64 16.64 21.25 35.89 41.35	14.06 14.06 18.67 33.33 38.78
STOP END	 Stop end int Stop end ext	GC450 GC455	4.93 4.93	3.25 3.25	GC150 GC155	5.44 5.44	3.65 3.65	GC550 GC555	6.39 6.39	4.25 4.25





PPC = Polyester Powder Coated supplied to our standard range of colours. When ordering PPC prefix code by 'X' and state colour and RAL number - see inside front cover.

② = Brackets are concealed when fixed to typical fascia and therefore will be supplied plain unless otherwise stated.



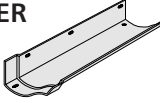

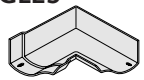

① = Please contact 01234 359438 for quote.

Aluminium Rainwater

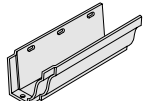

Victorian Ogee Cast Gutter System

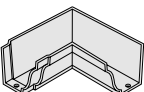
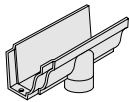
Description	100mm (4")			113mm (4½")			125mm (5")		
	Code	PPC	Plain	Code	PPC	Plain	Code	PPC	Plain
GUTTER  1.83m	GV406	52.53	39.36	GV106	68.23	52.61	GV506	72.24	55.76
UNION CLIP  (external)	GV420	7.51	5.63	GV120	9.74	7.44	GV520	12.70	10.19
FASCIA BRACKET 	GV480	6.53	5.29	GV180	8.86	7.33	GV580	9.50	8.15
ANGLES  90° int 90° ext 135° int 135° ext non std angle ①	GV430 GV431 GV435 GV436 GV439	14.56 14.56 13.09 13.09 POA	10.58 10.58 10.58 10.58 POA	GV130 GV131 GV135 GV136 GV139	20.50 20.50 19.34 19.34 POA	16.25 16.25 16.25 16.25 POA	GV530 GV531 GV535 GV536 GV539	22.32 22.32 41.47 41.47 POA	18.31 18.31 37.05 37.05 POA
OUTLET  63mm Ø 76mm Ø 72x72mm 102x76mm	GV422 GV423 GV425	21.82 21.82 58.30	17.93 17.93 52.11	GV122 GV123 GV125	22.19 22.19 58.50	17.93 17.93 52.11	GV522 GV523 GV525 GV526	29.25 29.25 65.53 65.53	24.43 24.43 58.60 58.60
STOP END  Left Hand (int) Right Hand (ext)	GV450 GV455	7.05 7.08	5.72 5.72	GV150 GV155	8.99 9.08	7.33 7.33	GV550 GV555	12.16 12.23	10.19 10.19

Moulded Ogee Cast Gutter System

Description	100 x 75mm (4 x 3")			125 x 100mm (5 x 4")			150 x 100mm (6 x 4")		
	Code	PPC	Plain	Code	PPC	Plain	Code	PPC	Plain
GUTTER 	GM406	94.25	80.07	GM506	82.52	65.14	GM606	124.02	105.36
UNION CLIP 	GM420	12.31	10.46	GM520	12.32	10.31	GM620	22.91	19.46
FASCIA BRACKET 	GM480	10.10	8.58	GM580	9.70	8.39	GM680	16.50	14.02
DIRECT FIX BRACKET 	GM481	4.34	3.29	GM581	4.34	3.29	GM681	4.34	3.29
ANGLES  90° int 90° ext 135° int 135° ext non std angle ①	GM430 GM431 GM435 GM436 GM439	22.54 22.54 22.54 22.54 POA	19.16 19.16 19.16 19.16 POA	GM530 GM531 GM535 GM536 GM539	25.13 25.13 25.13 25.13 POA	19.99 19.99 19.99 19.99 POA	GM630 GM631 GM635 GM636 GM639	37.12 37.12 37.12 37.12 POA	31.53 31.53 31.53 31.53 POA
OUTLET  63mm Ø 76mm Ø 102mm Ø 72x72mm 102x76mm 102x102mm	GM422 GM423 GM425 GM426	27.91 27.91 39.69 39.69	23.72 23.72 33.71 33.71	GM522 GM523 GM524 GM525 GM526 GM527	25.64 25.64 63.98 25.64 63.98 64.22	19.99 19.99 54.85 19.99 54.85 55.08	GM622 GM623 GM624 GM625 GM626 GM627	58.62 58.62 58.62 90.20 90.20 90.20	49.80 49.80 49.80 76.62 76.62 76.62
STOP END  Left Hand (ext) Right Hand (int)	GM450 GM455	11.72 11.72	9.96 9.96	GM550 GM555	13.32 13.32	10.75 10.75	GM650 GM655	22.91 22.91	19.46 19.46

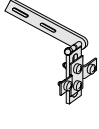
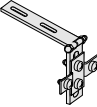

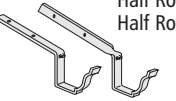
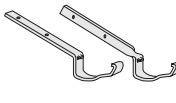
Rafter Arms

Description	Code	Black	
ADJUSTABLE			
  Side Top	AC78 AC77	7.29 7.29	
FIXED			
			
Half Round Side 100mm	AC71	9.21	8.04
Half Round Side 113mm	AC72	9.21	8.04
Half Round Side 125mm	AC73	9.21	8.04
Half Round Top 100mm	AC74	9.21	8.04
Half Round Top 113mm	AC75	9.21	8.04
Half Round Top 125mm	AC76	9.21	8.04
			
Moulded Ogee Side 100x75mm	AM71	11.54	10.38
Moulded Ogee Side 125x100mm	AM73	11.54	10.38
Moulded Ogee Side 150x100mm	AM75	11.54	10.38
Moulded Ogee Top 100x75mm	AM74	11.54	10.38
Moulded Ogee Top 125x100mm	AM76	11.54	10.38
Moulded Ogee Top 150x100mm	AM77	11.54	10.38
			
Victorian Ogee Side 100mm	AV71	10.38	9.21
Victorian Ogee Side 113mm	AV72	10.38	9.21
Victorian Ogee Side 125mm	AV73	10.38	9.21
Victorian Ogee Top 100mm	AV74	10.38	9.21
Victorian Ogee Top 113mm	AV75	10.38	9.21
Victorian Ogee Top 125mm	AV76	10.38	9.21

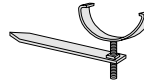
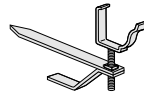
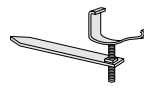
Rise & Fall Brackets

Description	Code	PPC	Plain
			
Half Round 100mm	AC91	10.57	
Half Round 113mm	AC92	10.57	
Half Round 125mm	AC93	10.75	
			
Moulded Ogee 100x75mm	AM91	16.15	
Moulded Ogee 125x100mm	AM93	16.15	
Moulded Ogee 150x100mm	AM94	16.15	
			
Victorian Ogee 100mm	AV91	16.15	
Victorian Ogee 113mm	AV92	16.15	
Victorian Ogee 125mm	AV93	16.15	

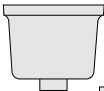
Hoppers

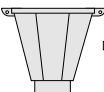
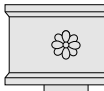

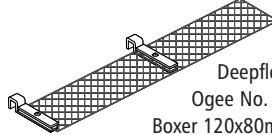
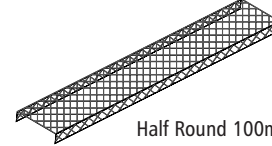

Description	Code	PPC	Plain
STANDARD			
 62x62mm	RH100	54.91	46.13
 63mm Circular	RH101	40.93	32.95
76mm Circular	RH102	42.46	34.46
102mm Circular	RH103	54.91	46.13
72x72mm	RH104	54.91	46.13
102x76mm	RH105	54.91	46.13
102x102mm	RH106	54.91	46.13
TRIANGULAR FLAT BACK			
 62x62mm	RH200	60.45	51.06
63mm Circular	RH201	31.63	23.02
76mm Circular	RH202	31.63	23.02
72x72mm	RH204	60.45	51.06
ORNAMENTAL			
 62x62mm	RH300	174.59	161.16
63mm Circular	RH301	174.59	161.16
76mm Circular	RH302	174.59	161.16
102mm Circular	RH303	174.59	161.16
72x72mm	RH304	174.59	161.16
102x76mm	RH305	174.59	161.16
102x102mm	RH306	174.59	161.16

Heavy Duty Leafguards



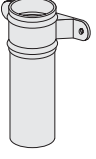

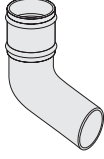
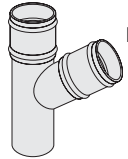

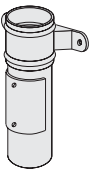
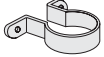
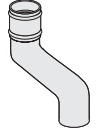
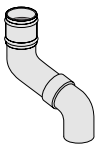
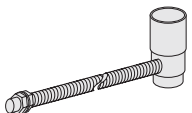
Description	Code	Plain
 Deepflow	SL102	11.64
Ogee No. 46	SL103	11.64
Boxer 120x80mm	SL105	11.64
Boxer 135x100mm	SL106	11.64
Boxer 160x100mm	SL107	11.64
Classic	SL101	11.64
Victorian Ogee 100mm	SL111	11.64
Victorian Ogee 113mm	SL113	11.64
Victorian Ogee 125mm	SL125	11.64
Moulded Ogee 100x75	SL114	11.64
Moulded Ogee 125x100	SL115	11.64
Moulded Ogee 150x100	SL116	11.64
Giant	SL225	14.08
Box Eaves	SL109	12.86
Viscount	SL31	11.64
 Half Round 100mm	SL71	11.64
Half Round 113mm	SL72	11.64
Half Round 125mm	SL73	11.64
Length: 1220mm		

Aluminium Rainwater

Circular Downpipe Systems

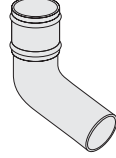
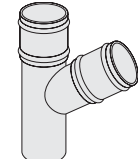
Description	63mm			76mm			102mm		
	Code	PPC	Plain	Code	PPC	Plain	Code	PPC	Plain
PIPE  1m ③ 2m ③ 3m ③	RR211	30.91	27.19	RR311	34.81	30.20	RR411	51.68	44.52
	RR212	45.95	37.44	RR312	51.83	41.71	RR412	78.43	62.68
	RR213	58.30	44.80	RR313	66.29	50.51	RR413	102.37	77.74
	Available with non eared socket ③								
LOOSE PIPE SOCKET  ③	RR220	9.68	8.24	RR320	12.92	11.21	RR420	20.44	17.58
BEND  Bend 92.5° Bend 112.5° Bend 135°	RR230	33.33	31.70	RR330	37.62	35.64	RR430	54.69	51.11
	RR232	19.03	17.08	RR332	24.19	21.81	RR432	30.83	27.03
	RR235	26.34	24.73	RR335	42.90	40.13	RR435	53.82	49.68
BRANCHES  Branch 92.5° Branch 112.5° Branch 135°	RR240	POA	POA	RR340	POA	POA	RR440	POA	POA
	RR242	37.49	33.92	RR342	43.63	40.76	RR442	59.56	54.81
	RR245	POA	POA	RR345	POA	POA	RR445	POA	POA
SHOE  ③	RR250	13.06	11.82	RR350	18.65	16.33	RR450	25.30	21.57
ACCESS PIPE  ③	RR260	40.77	38.80	RR360	47.63	44.90	RR460	57.22	52.65
PIPE CLIP  One Piece	RR280	6.91	5.79	RR380	7.21	5.85	RR480	8.16	6.83
FIXED OFFSETS  75mm 100mm 150mm 225mm 300mm	RR2903	40.51	38.96	RR3903	50.04	47.92	RR4903	61.58	58.28
	RR2904	40.72	38.96	RR3904	50.27	47.92	RR4904	61.88	58.28
	RR2906	41.02	38.96	RR3906	50.65	47.92	RR4906	62.33	58.28
	RR2909	49.73	46.76	RR3909	61.38	56.75	RR4909	73.49	67.99
	RR2912	50.23	46.76	RR3912	62.06	57.50	RR4912	74.47	67.99
	Non Standard Projections Available								
ADJUSTABLE OFFSETS  2 part adj to 450mm 2 part adj to 900mm Top bend to 450mm Top bend to 900mm Bottom bend	RR2945	53.70	49.69	RR3945	66.07	61.12	RR4945	91.42	83.41
	RR2990	59.57	53.67	RR3990	75.85	68.58	RR4990	107.51	95.83
	RR2974	35.86	32.99	RR3974	43.76	39.94	RR4974	58.92	54.98
	RR2979	40.08	35.50	RR3979	50.96	45.40	RR4979	73.43	64.63
	RR2972	21.87	20.21	RR3972	27.92	25.85	RR4972	38.57	34.63
	Non Standard Projections Available								
Min Offset Achievable 150mm			Min Offset Achievable 200mm			Min Offset Achievable 160mm			
RAINWATER DIVERTER KIT  Complete with black pvc-u flexible pipe	RRD25	40.00	37.89	RRD35	44.21	42.10			

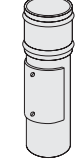

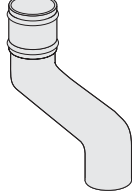
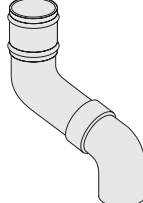
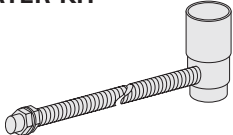



Vortex Downpipe System

Description	63mm			76mm		
	Code	PPC	Plain	Code	PPC	Plain
PIPE  1m 2m 3m	RC211 RC212 RC213	18.16 33.41 46.07	15.10 25.79 36.45	RC311 RC312 RC313	20.98 37.75 54.15	17.53 30.50 43.49
LOOSE PIPE SOCKET 	RC220	7.45	6.54	RC320	7.77	6.83
BEND  92.5° 112.5° 135°	RC230 RC232 RC235	14.60 14.60 14.60	11.97 11.97 11.97	RC330 RC332 RC335	16.18 16.18 16.18	13.54 13.54 13.54
BRANCH  112.5°	RC242	27.98	25.25	RC342	29.54	26.43
SHOE 	RC250	13.06	11.82	RC350	18.65	16.33
ACCESS PIPE 	RC260	39.61	36.94	RC360	44.69	42.75
PIPE CLIP  One Piece	RC280	2.57	1.93	RC380	2.86	2.11
FIXED OFFSETS  75mm 100mm 150mm	RC2903 RC2904 RC2906	24.11 24.11 24.11	21.01 21.01 21.01	RC3903 RC3904 RC3906	27.22 27.22 27.22	23.31 23.31 23.31
ADJUSTABLE OFFSETS  300mm 500mm 1000mm	RC2930 RC2950 RC29100	28.76 32.65 41.58	26.05 28.76 34.19	RC3930 RC3950 RC39100	33.42 37.30 48.17	27.61 31.87 38.87
RAINWATER DIVERTER KIT  Complete with black pvc-u flexible pipe	RRD25	40.00	37.89	RRD35	44.21	42.10

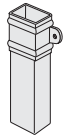

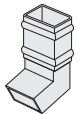
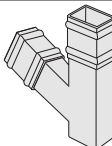
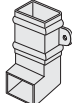
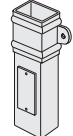

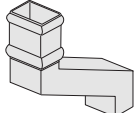
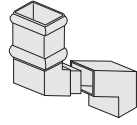

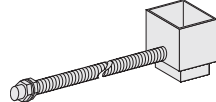
PPC = Polyester Powder Coated supplied to our standard range of colours. When ordering PPC prefix code by 'X' and state colour and RAL number - see inside front cover.

Aluminium Rainwater

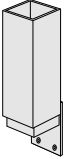
Square & Rectangular Downpipe Systems

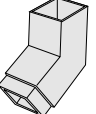
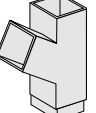
Description	72 x 72mm			102 x 76mm			102 x 102mm			
	Code	PPC	Plain	Code	PPC	Plain	Code	PPC	Plain	
PIPE 	1m ③	RSR311	48.11	42.23	RSR111	60.51	53.34	RSR411	57.62	49.93
	2m ③	RSR312	73.32	59.57	RSR112	96.27	79.78	RSR412	90.73	73.12
	3m ③	RSR313	95.40	73.62	RSR113	128.86	102.81	RSR413	121.16	93.30
	Available with non eared sockets ③									
LOOSE PIPE SOCKET 	③	RSR320	16.10	14.21	RSR120	18.08	15.90	RSR420	19.03	16.11
BEND 	92.5°	RSR330	50.44	47.76	RSR130 ④	57.52	53.52	RSR430	56.26	52.98
	112.5°	RSR332	50.44	47.76	RSR132 ④	57.52	53.52	RSR432	56.26	52.98
	135°	RSR335	50.44	47.76	RSR135 ④	57.52	53.52	RSR435	56.26	52.98
					See note 4 for handling					
BRANCHES 	92.5°	RSR340	POA	POA	RSR140 ④	POA	POA	RSR440	POA	POA
	112.5°	RSR342	81.84	75.01	RSR142 ④	90.15	84.67	RSR442	87.07	82.88
	135°	RSR345	POA	POA	RSR145 ④	POA	POA	RSR445	POA	POA
					See note 4 for handling					
SHOE 	③	RSR350	49.53	47.76	RSR150	55.90	53.52	RSR450	55.89	52.98
ACCESS PIPE 	③	RSR360	56.74	54.14	RSR160	62.38	58.90	RSR460	59.89	55.66
PIPE CLIP 	Two piece	RSR380	9.01	8.37	RSR180	8.09	7.29	RSR480	8.61	7.49
FIXED OFFSETS 	75mm	RSR3903	61.95	59.55	RSR1903 ④	68.59	65.58	RSR4903	73.90	63.49
	100mm	RSR3904	62.55	60.14	RSR1904 ④	69.45	66.22	RSR4904	76.44	64.73
	150mm	RSR3906	63.75	60.66	RSR1906 ④	70.70	66.94	RSR4906	80.01	67.27
	225mm	RSR3909	65.37	61.62	RSR1909 ④	72.55	68.27	RSR4909	81.71	68.69
	300mm	RSR3912	67.12	62.70	RSR1912 ④	74.92	69.62	RSR4912	84.12	70.05
	Non Standard Projections Available				See note 4 for handling					
ADJUSTABLE OFFSETS 	2 part adj to 450mm	RSR3945	87.37	82.92	RSR1945 ④	95.99	90.57	RSR4945	93.95	87.48
	2 part adj to 900mm	RSR3990	94.83	87.34	RSR1990 ④	105.26	96.31	RSR4990	104.24	93.63
	Top bend	RSR3972	55.94	54.48	RSR1972 ④	62.10	60.14	RSR4972	57.82	55.25
	Bottom bend to 450mm	RSR3974	31.42	28.40	RSR1974 ④	33.89	30.42	RSR4974	36.13	32.26
	Bottom bend to 900mm	RSR3979	38.90	32.83	RSR1979 ④	43.17	36.15	RSR4979	46.43	38.41
	Non Standard Projections Available				See note 4 for handling					
		Min Offset Achievable 75mm			Min Offset Achievable 75mm			Min Offset Achievable 100mm		
DRAIN CONNECTOR (SLIP SOCKET) 	Adapts to 110mm Circular	RSR370	52.60	50.94	RSR170	54.79	52.55	RSR470	57.16	54.15
RAINWATER DIVERTER KIT 		RSRD35	50.52	48.42	RSRD15	56.84	54.73			
Complete with black pvc-u flexible pipe										

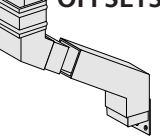
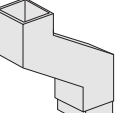
Vandal Resistant Downpipe Systems

Description	72 x 72mm			102 x 76mm			102 x 102mm			
	Code	PPC	Plain	Code	PPC	Plain	Code	PPC	Plain	
PIPE 	1m	RVR311	48.56	42.65	RVR111	61.08	53.87	RVR411	58.17	50.40
	2m	RVR312	74.01	60.16	RVR112	97.21	80.53	RVR412	91.59	73.82
	3m	RVR313	96.31	74.32	RVR113	130.06	103.77	RVR413	122.30	94.20
INTERNAL JOINT SPIGOT 		RVR320	5.97	4.56	RVR120	6.51	5.36	RVR420	8.16	6.77
BEND 	92.5°	RVR330	50.93	48.22	RVR130 ④	58.08	54.02	RVR430	56.76	53.48
	112.5°	RVR332	50.93	48.22	RVR132 ④	58.08	54.02	RVR432	56.76	53.48
	135°	RVR335	50.93	48.22	RVR135 ④	58.08	54.02	RVR435	56.76	53.48
	Complete with fixing plate				See note 4 for handing					
BRANCHES 	92.5°	RVR340	POA	POA	RVR140 ④	POA	POA	RVR440	POA	POA
	112.5°	RVR342	66.35	61.38	RVR142 ④	72.76	69.41	RVR442	68.70	67.39
	135°	RVR345	POA	POA	RVR145 ④	POA	POA	RVR445	POA	POA
	Complete with fixing plate				See note 4 for handing					
ACCESS PIPE 		RVR360	41.03	40.30	RVR160	44.75	43.42	RVR460	41.25	39.93
FIXING PLATE 		RVR380	7.73	6.96	RVR180	8.17	7.36	RVR480	8.70	7.59
ADJUSTABLE EAVES OFFSETS 	2 part adj to 450mm	RVR3945	94.44	89.05	RVR1945 ④	103.94	97.51	RVR4945	102.41	94.49
	2 part adj to 900mm	RVR3990	101.99	93.44	RVR1990 ④	113.08	103.19	RVR4990	112.60	99.01
	Top bend	RVR3972	56.47	55.01	RVR1972 ④	62.69	60.73	RVR4972	58.37	55.77
	Bottom bend to 450mm	RVR3974	39.20	35.22	RVR1974	42.64	38.07	RVR4974	45.31	40.03
	Bottom bend to 900mm	RVR3979	46.55	39.62	RVR1979	49.30	43.75	RVR4979	55.48	46.08
	Non Standard Projections Available		Min Offset Achievable 75mm		See note 4 for handing Min Offset Achievable 75mm			Min Offset Achievable 100mm		
WALL OFFSETS 			POA	POA		POA	POA		POA	POA
Complete with fixing plate Provide required dimensions with order (see design & installation guide)										
DRAIN CONNECTOR (SLIP SOCKET) 	To 110mm Circular	RVR370	52.60	50.94	RVR170	54.79	52.55	RVR470	57.16	54.19

No pipe clips required in this range. For connection to gutter outlet use conventional unneared socket.











PPC = Polyester Powder Coated supplied to our standard range of colours. When ordering PPC prefix code by 'X' and state colour and RAL number - see inside front cover.

④ = for 102 x 76mm left / right handing will be supplied unless otherwise stated.

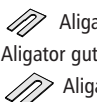
Aluminium Rainwater

Accessories

Please note that Sealant shelf life is 12 months

Description	Code	Price	Description	Code	Price		
SEALANT & CLEANER  Sealant tube clear Skeleton sealant gun Solvent cleaner litre (see inside front cover for sealant usage table) Please note that sealant shelf life is 12 months							
	SC101	6.71	ALUMINIUM NUTS, BOLTS & WASHERS PLAIN M6 x 20mm Aluminium bolt per 100 M6 Aluminium nut per 100 M6 x 15mm Aluminium washer per 100 				
	SC105	11.88		SC502	14.03		
	SC108	21.94		SC511	14.21		
COMPATIBLE FIXING SCREWS  32mm x No. 10 Roundhead 32mm x No. 10 Countersunk 50mm x No. 16 Domehead 38mm x No. 12 Domehead 50mm x No. 12 Countersunk 75mm x No. 16 Hexagonal							
	SC201	0.16	POLYESTER POWDER COATED BOLTS & PIPE SCREWS M6 x 20mm Aluminium bolt PPC 50mm x No. 16 Domehead PPC 75mm x No. 16 Hexagonal PPC 38mm x No. 12 Roundhead 				
	SC202	0.16		SC602	0.27		
	SC221	1.17		SC603	1.32		
	SC231	0.25		SC604	1.17		
	SC241	0.26		SC605	0.37		
	SC244	1.08					
PACKING SHIMS  Aligator gutter bracket GD580 Aligator gutter bracket GG580/GF080 Aligator gutter bracket GF480							
	SC380	0.53	TOUCH UP PAINT  Standard colours per ¼ litre			SC880	27.40
	SC381	0.55					
	SC382	0.52					
LIGHTNING CONDUCTOR  Universal link assembly Oxide inhibitor 225cc							
	SC401	6.01	PIPE SOCKET FILLER  10m Roll			SC911	11.23
	SC402	59.51					
GUTTER JOINT COMPRESSION TOOL 							
	SC104	13.37	CAST SPACER BOBBIN 30mm projection  Mill Finish PPC			SC701	4.63
					SC711	5.33	



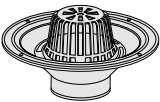
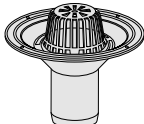
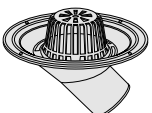
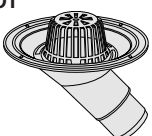

For fixing details see Design & Installation Guide

IMPORTANT: ONLY USE ALUTEC RECOMMENDED SUNDRIES, AS OTHER PRODUCTS MAY BE INCOMPATIBLE & IMPAIR THE LIFE EXPECTANCY OF THE SYSTEM.

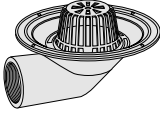
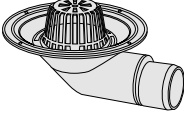

Roof Outlets

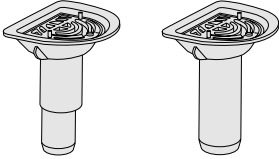
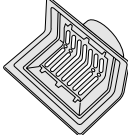
Nominal Size	Grate	50mm		75mm		100mm		150mm	
		Code	£	Code	£	Code	£	Code	£
VERTICAL THREADED 	Dome	DR215	124.20	DR315	103.99	DR415	138.55	DR615	173.66
	Flat	DR215F	124.20	DR315F	103.99	DR415F	138.55	DR615F	173.66
VERTICAL SPIGOT 	Dome	DR210	75.36	DR310	86.03	DR410	111.06	DR610	124.29
	Flat	DR210F	75.36	DR310F	86.03	DR410F	111.06	DR610F	124.29
45° THREADED 	Dome	DR225	209.84	DR325	209.84	DR425	242.47		
	Flat	DR225F	209.84	DR325F	209.84	DR425F	242.47		
45° SPIGOT 	Dome	DR220	145.73	DR320	152.72	DR420	183.03		
	Flat	DR220F	145.73	DR320F	152.72	DR420F	183.03		

Roof Outlets

Nominal Size	Grate	50mm Code	£	75mm Code	£	100mm Code	£	150mm Code	£
90° THREADED									
	Dome	DR235	114.24	DR335	115.42	DR435	155.05	DR635	312.42
	Flat	DR235F	114.24	DR335F	115.42	DR435F	155.05	DR635F	312.42
90° SPIGOT									
	Dome	DR230	103.99	DR330	112.49	DR430	143.39		
	Flat	DR230F	103.99	DR330F	112.49	DR430F	143.39		
BALCONY OUTLET									
	(Spigot)	DR260	76.46	DR360	81.94	DR460	91.23		
SHALLOW BALCONY OUTLET									
	(Spigot)	DR265	76.46	DR365	81.94				
TWO-WAY OUTLET									
	(Threaded)	DR250	86.03	DR350	90.13	DR450	91.23		
CAR PARK OUTLET									
	(Threaded)					DR480	195.27		
GULLY OUTLET									
	(Spigot)			DR370	122.56	DR470	116.15		











Accessories

Nominal Size		50mm Code	£	75mm Code	£	100mm Code	£	150mm Code	£
REFURBISHMENT ADAPTOR									
	enables 75mm dia spigot to push into existing 100mm dia outlet			DRH8	4.65				
THREADED ADAPTORS									
	300mm max	DRA2	19.38	DRA3	24.54	DRA4	32.29	DRA6	56.82

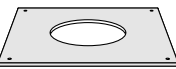
† Bolts Supplied

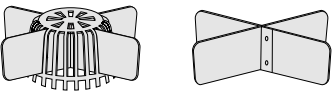

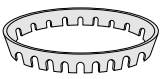

Aluminium Rainwater

Accessories

Nominal Size	Grate	50mm Code	£	75mm Code	£	100mm Code	£	150mm Code	£	
EXTENSION RING†		125mm max	DRE3	38.20	DRE3	38.20	DRE4	38.20	DRE4	38.20
EXTENSION RING†		Balcony Outlet 117mm max	DRE6	64.26	DRE6	64.26	DRE6	64.26		
EXTENSION RING†		Gully Outlet 125mm max			DRE7	64.26	DRE7	64.26		
TERRACE GRATE†		230 x 230mm	DRG8	28.29	DRG8	28.29	DRG8	28.29	DRG8	28.29
DECK SUPPORT		520 x 520mm 620 x 620mm	DRH3	43.14	DRH3	43.14	DRH4	53.62	DRH4	53.62
50MM CAST IRON CONNECTOR TO 55mm PVCu			DRH5	14.28						
ANTI-VORTEX FINIS	 Dome grate not included		DRH6	16.79	DRH6	16.79	DRH7	18.65	DRH7	18.65
GRATES		Dome	DRG1	22.64	DRG1	22.64	DRG2	23.34	DRG2	23.34
		Flat	DRG3	21.22	DRG3	21.22	DRG4	31.13	DRG4	31.13
CLAMPING RING			DRC1	21.22	DRC1	21.22	DRC2	24.05	DRC2	24.05
RAISING RING		Car Park Outlet				DRE1	26.88			

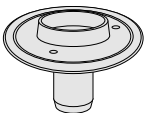
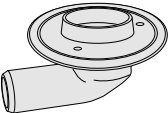
† Bolts Supplied

Aluminium Floor Outlets

Nominal Size	75mm		100mm	
	Code	£	Code	£
VERTICAL SPIGOT UNTRAPPED	DF310	54.73		
				
HORIZONTAL SPIGOT UNTRAPPED	DF315	58.94		
				
HORIZONTAL SPIGOT TRAPPED	DF330	104.20	DF430	104.20
 Includes dip tube				
HORIZONTAL SPIGOT TRAPPED	DF335	114.72	DF435	114.72
 2 x 2" BSP BOSS Includes dip tube & One blanking plug				
45° SPIGOT TRAPPED	DF340	88.41		
 Includes dip tube				
45° SPIGOT TRAPPED	DF345	91.57		
 2 x 2" BSP BOSS Includes dip tube & One blanking plug				

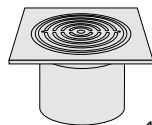
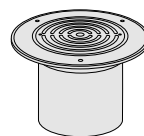

Nickel Bronze Grate Assemblies

Nominal Size Grate Size	150mm		200mm	
	Code	£	Code	£
CIRCULAR GRATE				
 150mm Spigot	DFG12	64.20		
Spigot = PVCu cut to size				
SQUARE TILE GRATE				
 150mm Spigot	DFG22	85.25	DFG32	111.57
Spigot = PVCu cut to size				
SHEET FLOORING GRATE				
 150mm Spigot			DFG42	114.72
Spigot = PVCu cut to size				
* For assembly with Blanking plate add suffix "B" to product code.				



Floor Outlets

Aluminium Shower Outlets

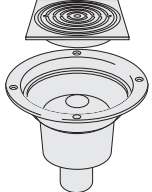
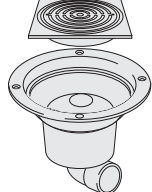
complete with universal pipe connector

Nominal Size	40mm Code	£
VERTICAL OUTLET - SHEET FLOORING  White PPC Aluminium grate Includes clamp and trap set	DF210	81.33
HORIZONTAL OUTLET - SHEET FLOORING  White PPC Aluminium grate Includes clamp and trap set	DF215	81.33
VERTICAL OUTLET - TILED FLOOR  Nickel Bronze grate Stainless Steel grate Includes clamp and trap set	DF230 DF232	158.93 99.25
HORIZONTAL OUTLET - TILED FLOOR  Nickel Bronze grate Stainless Steel grate Includes clamp and trap set	DF235 DF237	158.93 99.25

Spares

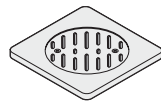
Nominal Size	40mm Code	£
BLANKING PLATE FOR SHEET FLOOR  White PPC Aluminium	DFB230	POA
TILE GRATE  Nickel Bronze  Stainless Steel	DF230T DF250T	85.25 25.58

General Information

All list prices are for single components unless marked.

This price list does not constitute an offer. All prices are subject to change without notice and are exclusive of VAT. A sum equivalent to the VAT chargeable will be invoiced for payment by the customer. Customer attention is drawn to the Company's official Terms and Conditions of Sale. Goods are supplied strictly in accordance with these terms and conditions, copies of which are freely available on request.

Note:

Alutec products are manufactured to a constant high standard. Marley Plumbing & Drainage will not therefore accept responsibility for failure of any installation which includes components not supplied by us.

Roof Outlets are manufactured in Aluminium. Grates and clamp rings or flanges are Polyester Powder Coated.

Floor and Shower outlets are manufactured in Aluminium except where stated. Floor and Shower outlets are Polyester Powder Coated.

Important

Before despatching your order please check that you have ordered the appropriate amount of Sealant, Solvent Cleaner, Screws, Nuts/Bolts/Washers and Touch-up Paints. Where applicable when ordering, please clearly quote the colour and the RAL Code.



Further information

For Technical advice please call **01234 344108**
For general enquiries please call **01234 359438**
email: enquiries@marleyalutec.co.uk

marleyalutec.co.uk

Head Office

Lenham, Maidstone, Kent ME17 2DE

Scotland

Birkenshaw Industrial Estate, Uddingston, Glasgow G71 5PA
Telephone: **01698 815231** Fax: **01698 810307**

Export Division

Lenham, Maidstone, Kent ME17 2DE England
Telephone: **+44 (0)1622 858888** Fax: **+44 (0)1622 850778**

